

THE BANDWIDTH OF HEB MIXERS EMPLOYING ULTRATHIN NbN FILMS ON SAPPHIRE SUBSTRATE

*P. Yagoubov, G. Gol'tsman, B. Voronov, L. Seidman, V. Siomash, S. Cherednichenko, and
E. Gershenson*

Department of Physics, Moscow State Pedagogical University, Moscow 119435, Russia

Abstract

We report on some unusual features observed during fabrication of ultrathin NbN films with high T_c . The films were used to fabricate HEB mixers, which were evaluated for IF bandwidth measurements at 140 GHz. Ultrathin films were fabricated using reactive dc magnetron sputtering with a discharge current source. Reproducible parameters of the films are assured keeping constant the difference between the discharge voltage in pure argon, and in a gas mixture, for the same current. A maximum bandwidth of 4GHz at optimal LO and dc bias was obtained for mixer chip based on NbN film 35 Å thick with $T_c=11K$.

1. Introduction

A fundamental problem of the bolometer mixers is to achieve a wide IF bandwidth. For phonon cooled HEB mixers based on NbN thin films, the maximum value of the IF bandwidth calculated from the electron-phonon relaxation time at T_c , $\tau_{eph}(T_c)$, is relatively high, and can reach 10 GHz [1]. For the diffusion cooling mechanism [2] it is only limited by how small the distance between the contacts can be made by lithography and can well be of the same order of magnitude. At the same time, recently reported values of the IF bandwidth for both types of HEB mixers amount to 1.5-2 GHz [3,4]. To extend the frequency bandwidth in the first type of mixers, a significant progress in film technology is required, which could allow one to obtain very thin NbN films with high critical temperature T_c and critical current density j_c at 4.2 K.

In this paper we report on the features of the fabrication technique of ultrathin NbN films with high T_c and high critical current density $j_c(4.2\text{ K})$, as well as the fabrication of HEB mixers based on these films with an IF bandwidth of 4 GHz, measured at a frequency of 140 GHz with optimal LO and DC bias.

2. Manufacture of NbN ultrathin films

The NbN superconducting thin films were fabricated using reactive dc magnetron sputtering in an Ar + N₂ mixture [5]. As a sputtering source a planar magnetron device with a Nb target was used. The main process parameters are given in Table 1.

Table 1

Process Parameters	Values
Target diameter	110 mm
Target-substrate distance	80 mm
Residual pressure	0.2 mPa
Argon pressure	0.12 Pa
Discharge current	600 mA
Discharge voltage in Argon	370 V
Discharge voltage in Argon-Nitrogen mixture	405 V
Deposition rate	0.2 nm/s
Substrate temperature	900 K

$\Delta U = 35\text{ V}$

Reproducible fabrication of ultrathin NbN films with a sufficiently high T_c is only possible if the partial pressures of the working and the reactive gases (Ar and N₂) are carefully controlled. One can hardly doubt that it is difficult to simultaneously maintain exact pressure values, which differ by an order of magnitude, of two gases taking part in a reaction.

In this work we maintained the composition of the gas mixture by controlling the working point on the IV-curve of the gas discharge with magnetron sources operating under the conditions of direct current stabilization.

This point deserves a more detailed consideration. Normally, for the reactive magnetron sputtering of NbN, voltage or discharge power stabilization is used. We studied these conditions as well. It turned out that under the above conditions two stable discharge states exist which correspond to two states of the target surface, either with or without a NbN coating. In the first state, films are deposited with excessive nitrogen, and in the second state with excessive niobium [6]. As a consequence of self-evolving processes of NbN deposition or removal, the intermediate states of the target and of the discharge are unstable. However, it is these states that are the most interesting, since under this particular condition, films may be deposited with a stoichiometric composition. Indeed, consider a typical IV-curve of a magnetron operating under the conditions of discharge voltage stabilization (Fig.1). At low discharge voltages, the NbN deposition rate on the target surface exceeds its sputtering rate, and the target is fully coated with NbN. At a certain critical voltage, the NbN sputtering rate becomes higher than the deposition rate of NbN on the target, and a part of the target surface is depleted of ~~Nb~~^{NbN}. The sputtered Nb atoms absorb more and more nitrogen, and the pressure of the nitrogen decreases. This entails a still greater decrease of the NbN deposition rate on the target surface, which is thus further depleted of ~~Nb~~^{NbN}. Consequently, the current is grows, since the NbN emission factor is smaller than that of Nb. The gas mixture discharge characteristics approach the IV-curve of pure argon. If the discharge voltage is afterwards reduced, then the nitrogen will still be almost completely absorbed by the sputtered niobium, but only up to a certain critical voltage value. At this value, the target sputtering rate is so much decreased that on its surface NbN

N₂ raises
existence of
plasma

Nb + NbN ions carry virtually
no current

deposition is renewed. As a result, the current drops by a leap, and the target is quickly coated with NbN.

Let us now consider the discharge characteristics for the magnetron operating under the current stabilization condition. The IV curves for different initial nitrogen pressure under this condition are shown in Fig.2. They are S-shaped, i.e. the hysteresis effect does not take place. This results from a self-compensation of the deviations of the discharge from the equilibrium state under the conditions of current stabilization. For example, if the sputtering rate increases, an additional part of the target surface is depleted of NbN, and the number of Nb atoms absorbing nitrogen increases. The nitrogen pressure in the discharge decreases together with the discharge voltage; hence, the sputtering rate returns to its initial value. Conversely, if the sputtering rate decreases, the target area coated by Nb enlarged. The discharge voltage rises, due to which fact the sputtering rate is restored.

Therefore, there is a one-to-one correspondence between the discharge voltage U , the nitrogen partial pressure in the discharge, and the fraction of the target coated by NbN. The higher the nitrogen partial pressure in the discharge, the higher the discharge voltage in the mixture. This fact makes it possible to estimate the value of the nitrogen partial pressure in the discharge, using the quantity $\Delta U = U - U_{Ar}$ which can be measured easily (U_{Ar} is the discharge voltage in pure argon for a given stabilized current, and U is the discharge voltage in a gas mixture for the same current, see Fig.2).

An additional point emphasize is that if ΔU is kept constant, reproducible parameters of the deposited films are OK due to an automatic regulation of the

residual environment, the magnetic field of the magnetron, and the condition of the target.

The optimal ΔU value was chosen by maximizing the critical temperature value of the transition of the deposited film to the superconducting state (T_c). Fig. 3 presents the dependence of T_c upon ΔU for sapphire-based NbN films 4 nm thick, which confirms the possibility of controlling the film composition using only the electrical parameters of the discharge.

In the current work, changes of the film properties have also been studied when their thickness was reduced to 2-3 nm. A considerable growth of the influence of the substrate is then observed. For substrates we used sapphire (1012), high resistive silicon (100), and Z-cut single crystal quartz. The film thickness was measured using a Talystep profilometer-profilograph. The resistivity of the 10 nm thick NbN films was about $160 \mu\text{Ohm}\times\text{cm}$, i.e. it was substantially smaller than that reported in [7] for films of the same thickness. The films on sapphire had the lowest resistivity (Fig. 4). The sheet resistance of those films was 15-20% lower than that of the films deposited on single crystal quartz, and 30-40% lower than for the films deposited on Si substrates.

The NbN films deposited on sapphire had high T_c values even though their thickness was reduced to 3 nm. This is in a good agreement with the results reported in [8]. For films on other substrates, the results were slightly worse. It must be noted that a decrease of T_c was accompanied by an increase of the transition width (Fig. 4).

3. Experiment and discussion

The ultrathin NbN films on sapphire substrates were used for photolithographic production of mixer chips. Every chip consisted of 16 parallel strips 0.7 μm wide and 2 μm long each, placed between the contact pads. There was a 1.2 μm space between the strips. The device was mounted on a waveguide flange, as shown on Fig.6.

The setup used for bandwidth measurements is presented in Fig.5. Two BWOs operating at 120-145 GHz were used as local oscillator and signal source. An additional bias in the LO power circuit allowed us to vary its frequency. The LO and signal radiation were coupled by a beam splitter and a beam waveguide into the cryostat. Two attenuators included in the quasi-optical line allowed us to adjust the signal and LO power, and to maintain optimum LO power during the retuning. The IF signal received from the mixer was amplified by a room temperature wideband amplifier (0.1-20 GHz), and was sent to the input of the spectrum analyzer.

Fig. 7 shows experimental data on the output signal vs. IF frequency for three mixer chips based on NbN films 50 \AA (No.1), 35 \AA (No.2), and 25 \AA (No.3) thick, at a temperature of 4.2 K, and with optimal bias of P_{DC} and P_{LO} . These results show that the mixer based on the 35 \AA thick film has the widest 4 GHz bandwidth in the optimal working point, while for 50 \AA and 25 \AA films, the bandwidth is 1 GHz and 1.8 GHz, respectively.

Let us now discuss the factors which influence the IF bandwidth of a real phonon cooled HEB mixer. As already mentioned, its maximum bandwidth is limited by the electron-phonon relaxation time τ_{eph} (T_c) at T_c . At $T_c \approx 10$ K this bandwidth is about 10 GHz [1]. However, near the optimal operating point even the

bandwidth of an ideal HEB mixer is narrowed due to the self-heating by the bias current and can be calculated as

$$\Delta F = \frac{1}{2\pi\tau_{\text{eph}}(T_c)} \cdot \left(1 - C \cdot \frac{R_L - R}{R_L + R} \right),$$

where $C = I^2(dR/dT)/G$ is the self-heating parameter, G is the thermal conductivity between the electron and phonon subsystems, respectively and R is device resistance.

The term $(1 - C \cdot \frac{R_L - R}{R_L + R})$ which narrows the IF bandwidth usually yields a factor of 2-3 [4]. This means that for mixer chip No. 2 (35 Å) the IF bandwidth achieved can be explained in the framework of the pure electron-phonon cooling HEB mixer model.

The increase of the thickness entails a significant bandwidth limitation because of the thermal resistance of the NbN film/substrate boundary, which may be characterized as the transmission coefficient of thermal phonons through the boundary. This coefficient is about 0.1. The phonon escape rate is in this case proportional to the film width d , and for mixer chip No. 2 at T_c approaches the electron-phonon rate. This accounts for the fact that chip No.1 has a lesser bandwidth as compared to mixer chip No. 2. For mixer chip No. 3 with the smallest width (25 Å), T_c is significantly lower and the bandwidth cannot exceed ≈ 6 GHz, since $\tau_{\text{eph}} \approx T^{-1.6}$ [1]. There exists, however, one more important factor that can decrease the IF bandwidth. Its final manifestation is the essential reduction of the critical current density at 4.2 K for such thin films. For high quality thin NbN films $j_c(4.2\text{K})$ reaches $1+2 \times 10^7$ A/cm² and corresponds to the vortex tear-off from the pinning centers. Their viscous flow creates a quasihomogenous resistive state, in the case when no heat domains are formed, in which the viscous flow of vortices is much more

intensive. In any case, the electron temperature due to RF and DC power heating up to the optimum mixing point remains noticeably lower than T_c , since the bias current is only 2-3 times lower than the critical current at the ambient temperature. The viscous flow of vortices makes an essential contribution to the resistivity. Yet thinner films (in our case 25 Å and less) cease to be homogenous, and the critical current density drops drastically. The weak parts of the film turn to the normal state at such a low value of the bias current that the heating by P_{LO} and P_{DC} is small, and the mixer bandwidth at the ambient temperature $T=4.2\text{K}$ cannot exceed $\Delta f_{IF} \leq 1/2\pi\tau_{eph}(4.2\text{ K})$. On the contrary, for NbN films 35 Å thick, with $T_c=11\text{ K}$ and $j_c(4.2\text{ K})=1-2 \cdot 10^7\text{ A/cm}^2$, the IF bandwidth of the electron-phonon cooled HEB mixer amounts to 4 GHz. A further extension of the IF bandwidth is possible with the increase of T_c and $j_c(4.2\text{ K})$ for ultrathin NbN films. It must also be noted that the noise temperature bandwidth is still wider than that of the conversion gain.

4. Acknowledgments

This work has been supported by Russian Program on Condensed Matter (Superconductivity Division) under Grant No. 93169. The authors wish to thank E.M.Menstchikov for his assistance in the fabrication of the devices.

5. References

1. Yu.P. Gousev, G.N. Gol'tsman, A.D. Semenov, E.M. Gershenson, R.S. Nebosis, M.A. Heusinger, and K.F. Renk. "Broadband Ultrafast Superconducting NbN Detector for Electromagnetic Radiation." *J. Appl. Phys.*, vol.75, No 7, pp.3695-3697, 1994.
2. D.E. Prober. "Superconducting terahertz mixer using a transition-edge microbolometer." *Appl. Phys. Lett.*, v.62, pp. 2119-2121, 1993.
3. A.Skalare, W.McGrath, B.Bumble, H.LeDuc, P.Burke, A.Verheijen, and D.Prober. "Noise Temperature and IF Bandwidth of 530 GHz Diffusion-cooled

- Hot-electron Bolometer Mixer." Proc. of the 6th Int. Symp. on Space Terahertz Tech., Caltech, Pasadena, pp.262-267, 1995.
4. O.Okunev, A.Dzardanov, G.Gol'tsman, and E.Gershenzon. "Performances of Hot-Electron Superconducting Mixer for Frequencies Less than the Gap Energy: NbN Mixer for 100 GHz Operation." Proc. of the 6th Int. Symp. on Space Terahertz Tech., Caltech, Pasadena, pp. 247-253, 1995.
 5. B.Voronov, G.Gol'tsman, E.Gershenzon, L.Seidman, T.Gubkina, and V.Siomash. "Superconductive properties of NbN ultrathin films on different substrates." *Sverkhprovodimost'*: Fiz., Chim., Tekh., v.7, N 6, 1097-1102, 1994 (in Russian).
 6. B.Voronov, M.Budjanski, L.Seidman, and T.Gubkina. "The improvement of reproducibility of NbN thin films fabrication." *Sverkhprovodimost'*. Fiz., Chim., Tekh., v.5, N10, 1950-1954, 1992 (in Russian).
 7. Westra K.L., Brett M.J., Vaneldik J.F. *J.Vac.Sci.Technol.A.*, v.8,N 3, pp.1288-1293, 1990.
 8. T.Yamashita , K.Hamasaki , Y.Kodaira , and T.Komata "Nano-meter bridge with epitaxially growth of NbN on MgO film." *IEEE Transactions on magnetics*, v.MAG-21, N 2, pp.932-934, 1985.

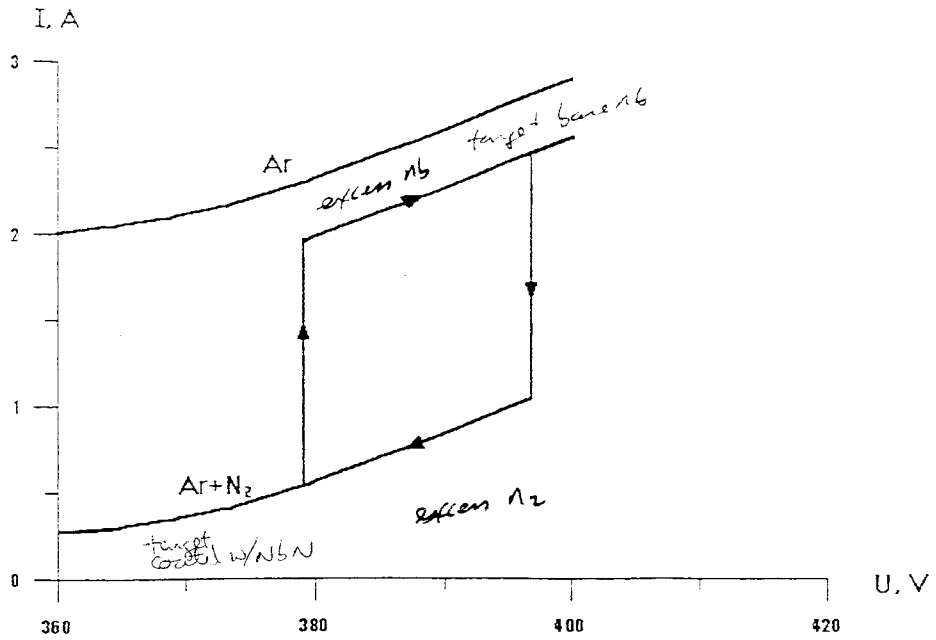

Figure 1.
IV-curves of discharge for magnetron operation under the voltage stabilization condition

higher $p_{Ar_2} \rightarrow$ higher voltage at constant current

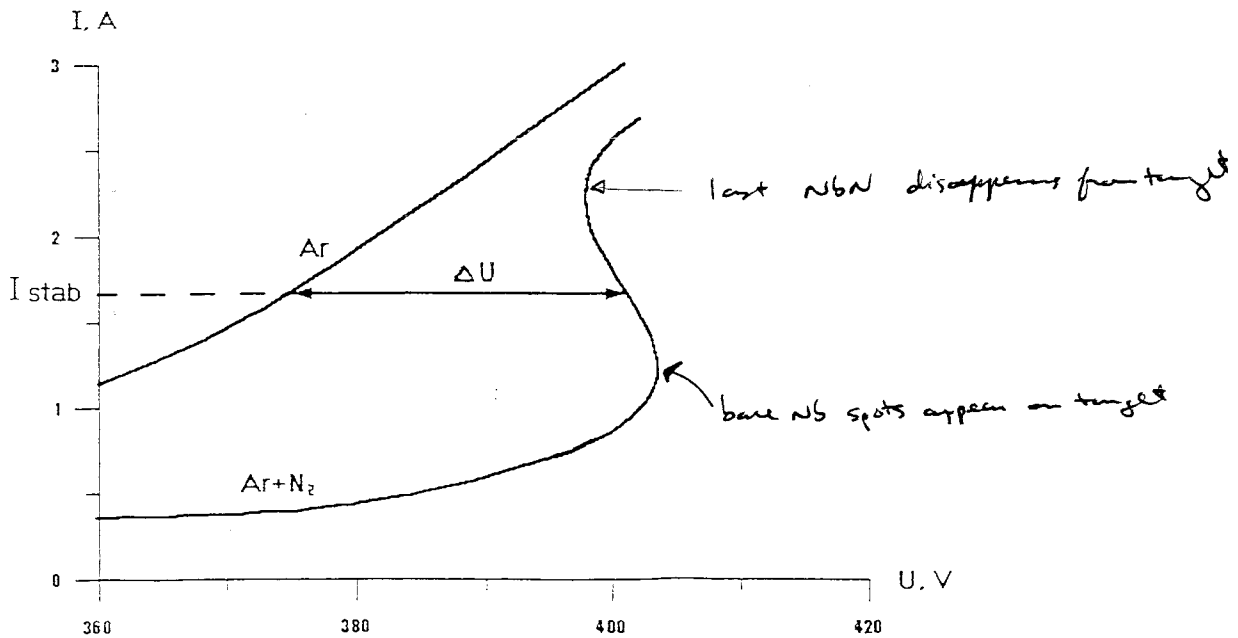
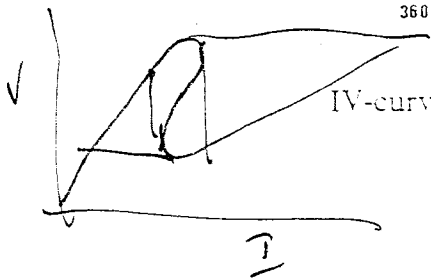

Figure 2.
IV-curves of discharge for magnetron operation under the current stabilization condition



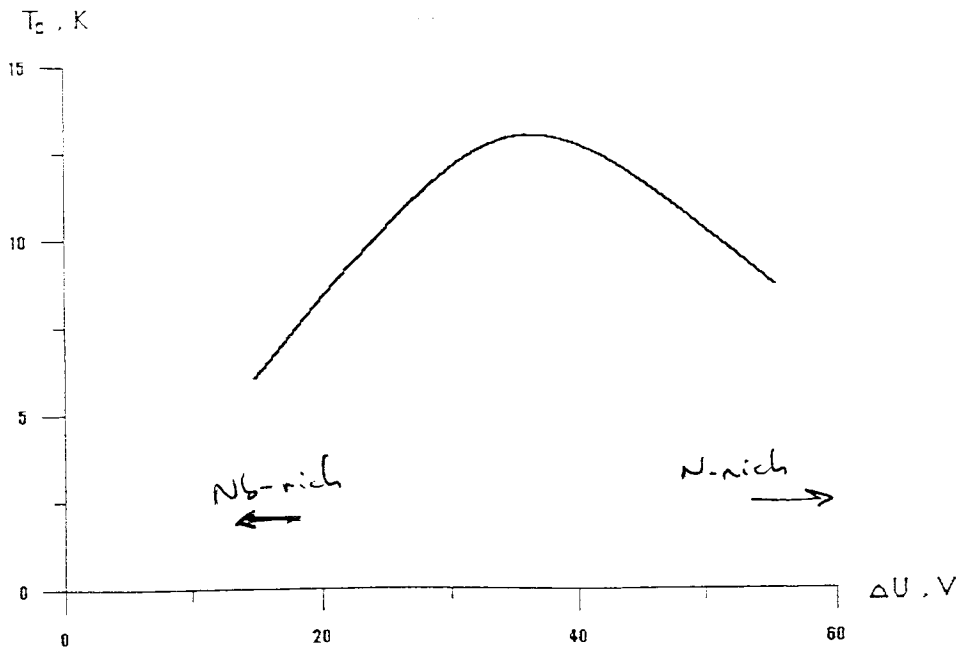

Figure 3.
Critical temperature for NbN film 40 Å thick on sapphire vs. ΔU

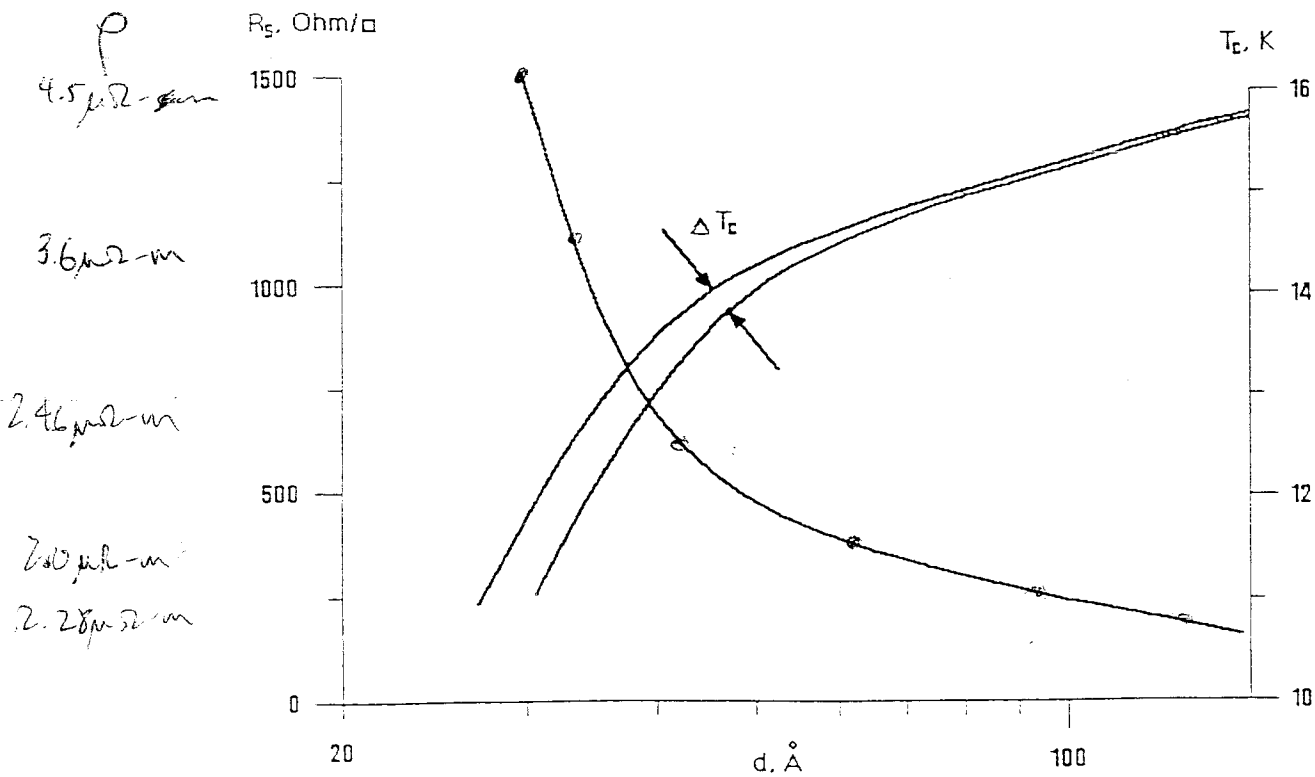

Figure 4.
Resistivity and critical temperature for NbN films on sapphire vs. film thickness

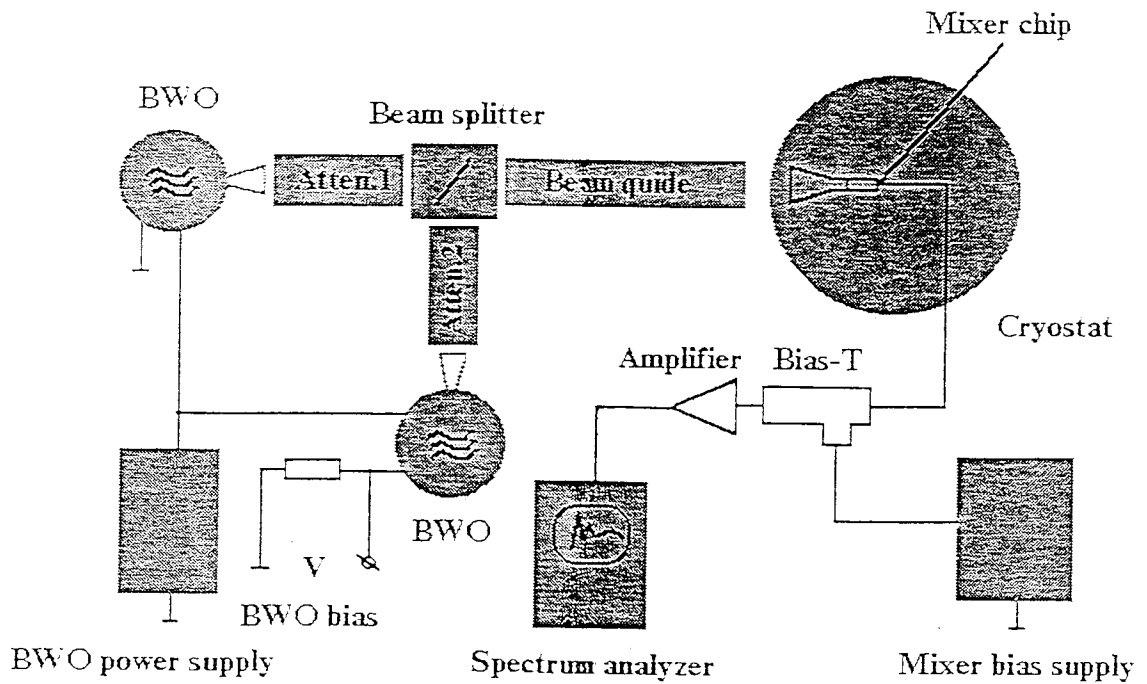

Figure 5
Set-up for bandwidth measurements

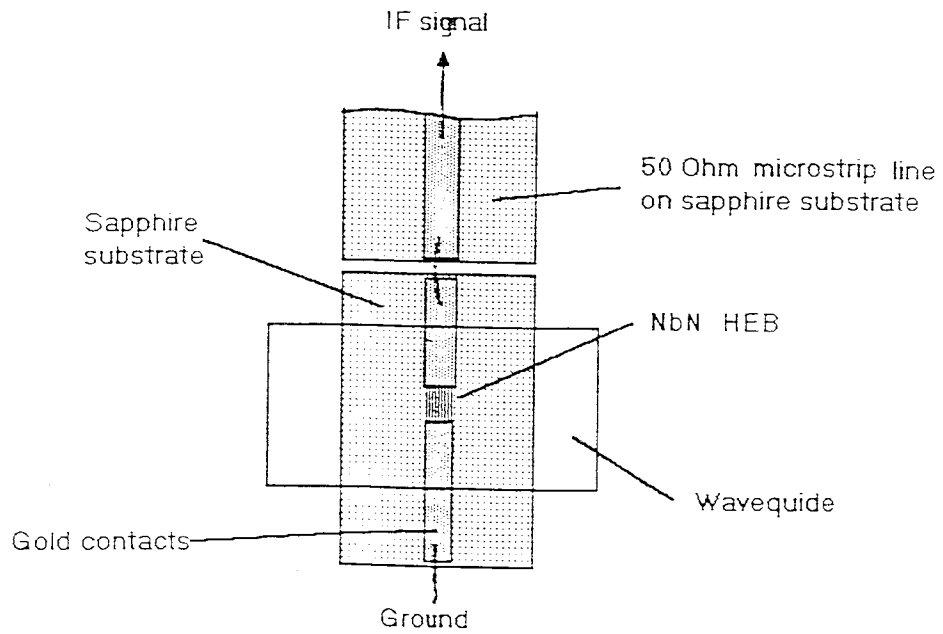

Figure 6
View of the mixer chip on the waveguide flange

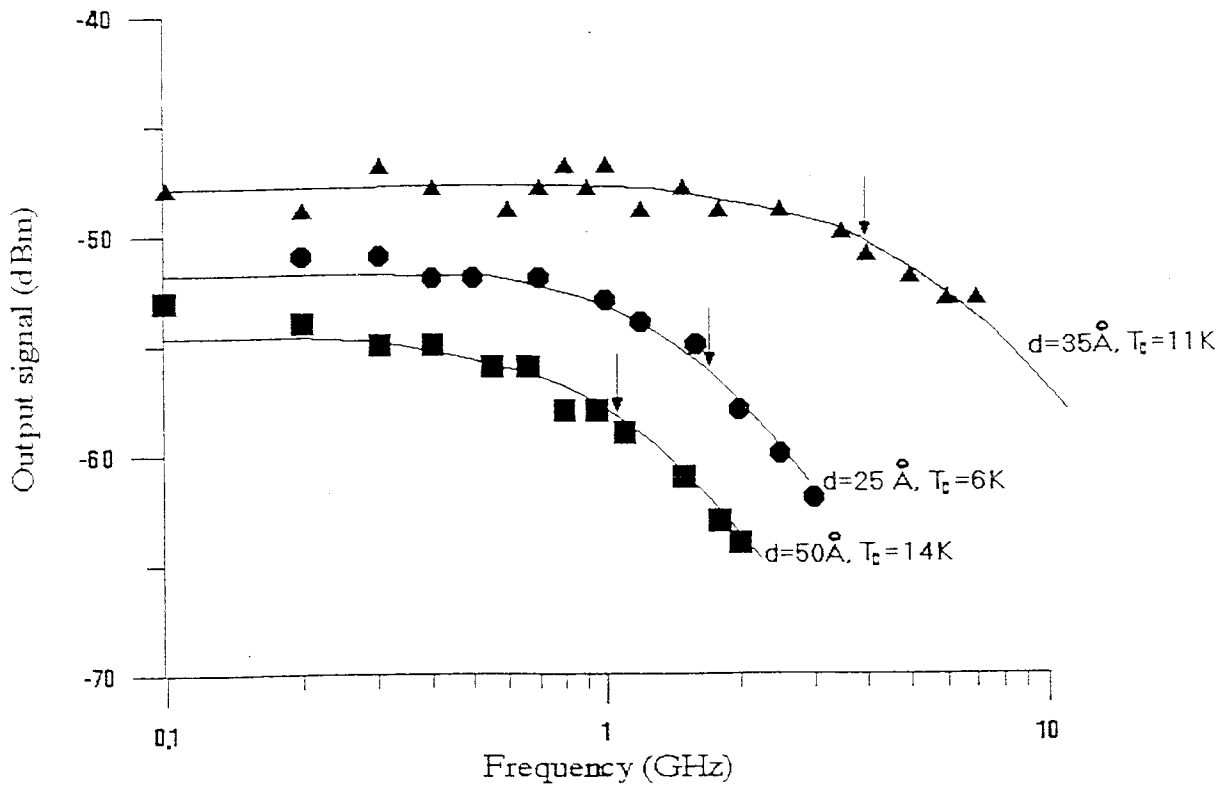

Figure 7.
Output signal vs. Intermediate frequency for mixer chips based on NbN film
50 Å, 35 Å, 25 Å thick